

Skjutlag 1	Tavla 34	Sven Berglund	
1 Luft		Nysätra Pistolklubb	H/D 70
22.04.2023		Vårträfen 2023	Umeå skytteallians
Serie 1		1: 8.5 ← 2: 10.5x → 3: 10.3 ↑ 4: 9.7 ↓ 5: 8.2 ↗ 6: 10.2 ← 7: 9.0 ↗ 8: 7.5 ↑ 9: 9.2 ↑ 10: 8.7 ←	Serie 2
	1: 10.5x ↖ 2: 7.3 ← 3: 9.9 ← 4: 9.1 ↑ 5: 7.9 ↗ 6: 10.0 ↙ 7: 10.3 ↗ 8: 9.7 ↑ 9: 8.5 ↗ 10: 9.1 ↖	Serie 88 (1x)	Serie 88 (1x)
Total 88 (1x)	Total 176 (2x)	Serie 88 (1x)	Total 176 (2x)
Serie 3		1: 9.6 ↖ 2: 8.4 ← 3: 8.7 ↓ 4: 9.2 ← 5: 8.4 ← 6: 9.1 ↑ 7: 10.7x ↖ 8: 9.2 ↙ 9: 10.3 ↓ 10: 8.8 ↑	Serie 4
	1: 10.0 ↑ 2: 8.8 ← 3: 9.5 ↗ 4: 9.9 → 5: 9.4 ← 6: 10.7x ↖ 7: 9.6 ← 8: 10.1 ↗ 9: 8.3 ↗ 10: 9.8 →	Serie 88 (1x)	Serie 91 (1x)
Total 264 (3x)	Total 355 (4x)	Total 264 (3x)	Total 355 (4x)
Serie 5		1: 10.2 ↑ 2: 9.8 ↓ 3: 9.7 ↙ 4: 10.0 ↓ 5: 10.0 ↗ 6: 9.6 → 7: 9.6 → 8: 8.3 ↓ 9: 10.8x ↖ 10: 8.0 ↓	Serie 6
	1: 8.5 ↗ 2: 8.0 ↓ 3: 9.5 ↑ 4: 9.5 ← 5: 7.7 ↙ 6: 10.3 ↓ 7: 9.8 ↘ 8: 8.9 ← 9: 9.5 ← 10: 8.2 ↘	Serie 92 (1x)	Serie 85 (0x)
Total 447 (5x)	Total 532 (5x)	Total 447 (5x)	Total 532 (5x)

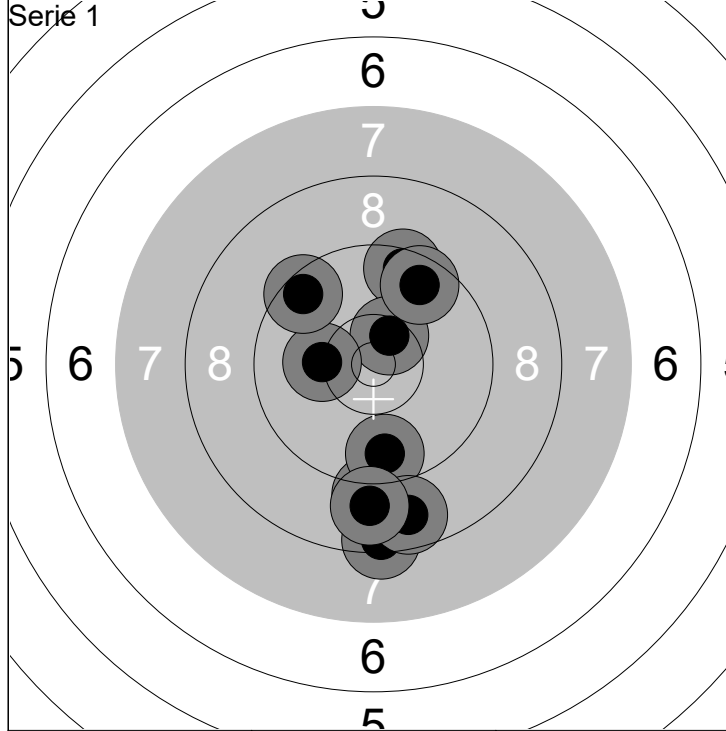

1: 9.1 ↓	6: 9.6 ↗	Serie 89 (1x)
2: 9.5 ↗	7: 10.2 ←	
3: 10.5x ↗	8: 9.5 ↖	Total 89 (1x)
4: 9.6 ↓	9: 8.7 ↓	
5: 8.4 ↓	10: 8.9 ↓	

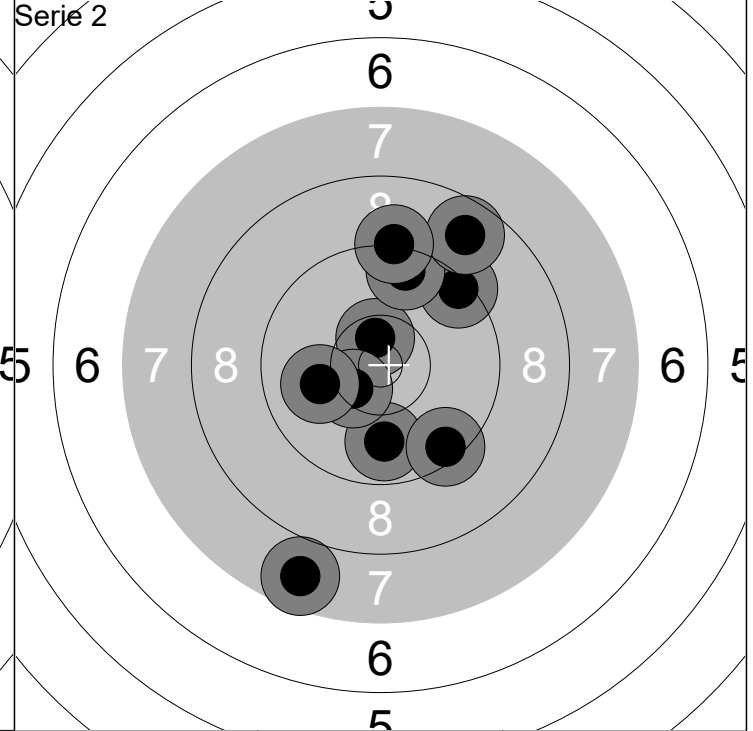

1: 10.5x ↗	6: 10.4x ↙	Serie 90 (2x)
2: 7.7 ↓	7: 10.0 ←	
3: 9.8 ↓	8: 8.7 ↗	Total 179 (3x)
4: 9.4 ↗	9: 9.4 ↘	
5: 9.5 ↗	10: 9.2 ↗	

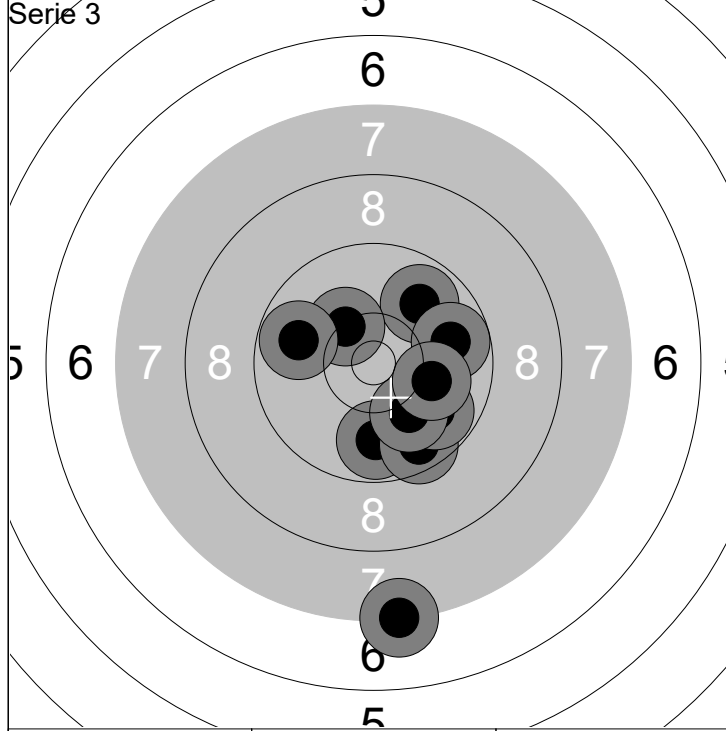

1: 7.3 ↓	6: 10.3 ↗	Serie 91 (0x)
2: 9.8 ↓	7: 9.8 ←	
3: 9.6 ↓	8: 9.8 →	Total 270 (3x)
4: 9.8 ↘	9: 10.1 ↓	
5: 9.9 ↗	10: 10.1 →	

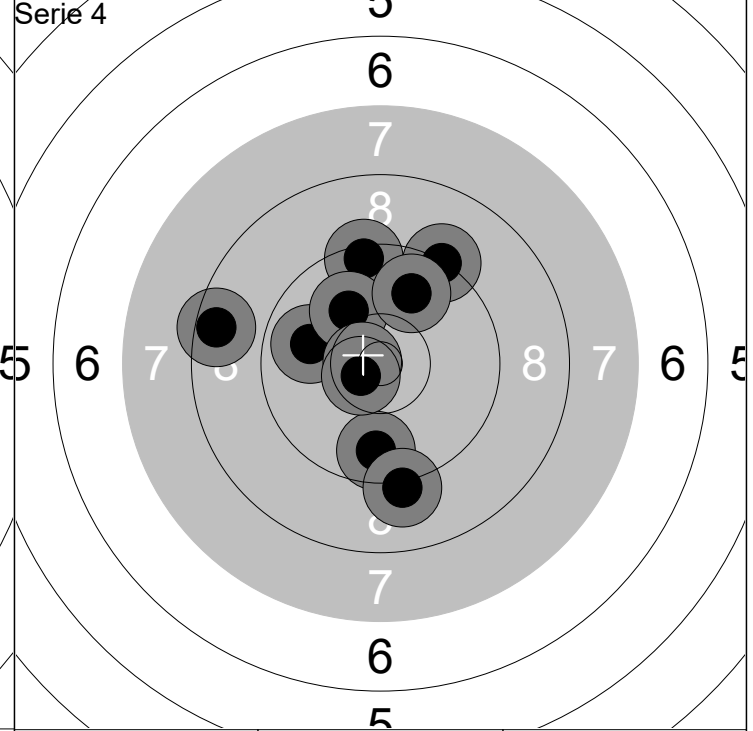

1: 9.9 ←	6: 9.8 ↗	Serie 92 (2x)
2: 9.4 ↗	7: 9.1 ↓	
3: 9.7 ↓	8: 8.5 ←	Total 362 (5x)
4: 9.2 ↗	9: 10.7x ←	
5: 10.0 ↖	10: 10.6x ↙	

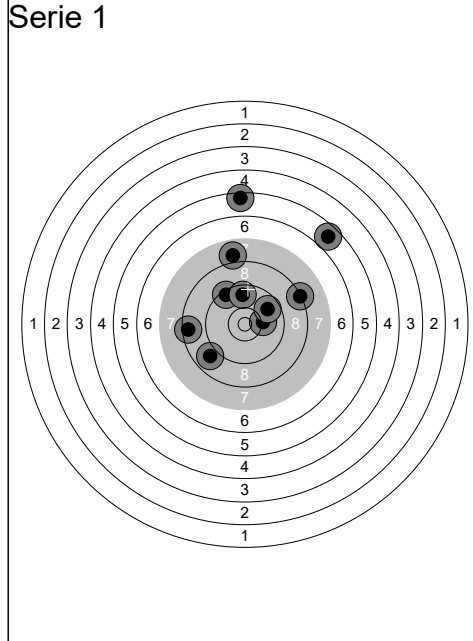

1:	10.1	→
2:	8.9	↙
3:	5.4	↑
4:	7.9	↑
5:	8.2	→
6:	9.7	↗
7:	9.4	↖
8:	8.5	←
9:	5.7	↗
10:	9.7	↑
Serie		78 (0x)
Total		78 (0x)

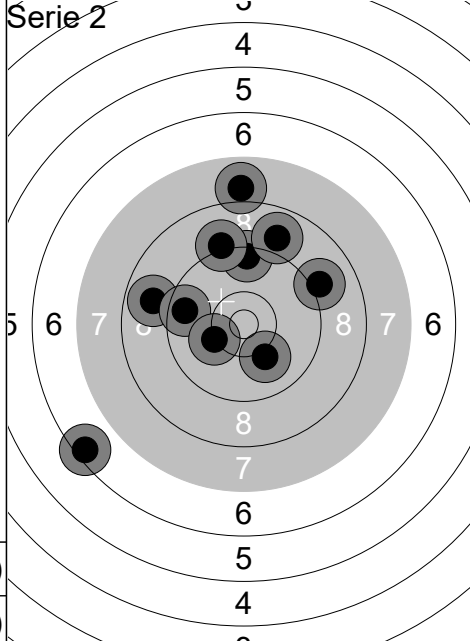

1:	6.4	↘
2:	9.4	↑
3:	8.8	←
4:	9.0	↗
5:	9.6	←
6:	9.1	↑
7:	8.9	↑
8:	10.2	←
9:	7.9	↑
10:	10.1	↘
Serie		85 (0x)
Total		163 (0x)

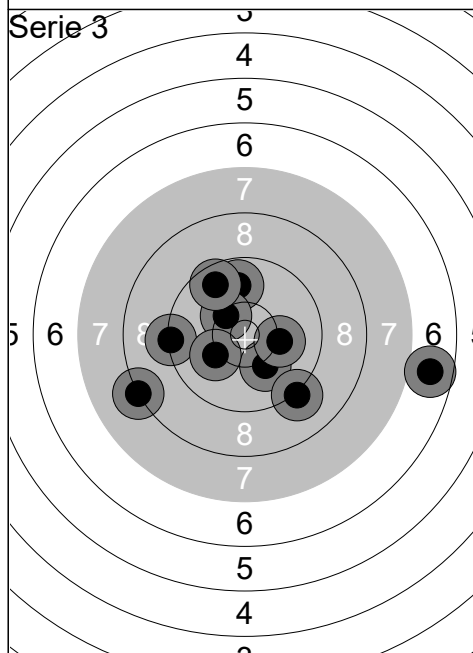

1:	8.2	↙
2:	9.3	←
3:	10.1	↘
4:	9.8	↑
5:	9.2	↘
6:	10.3	↗
7:	10.2	→
8:	10.2	↙
9:	9.6	↗
10:	6.7	→
Serie		90 (0x)
Total		253 (0x)

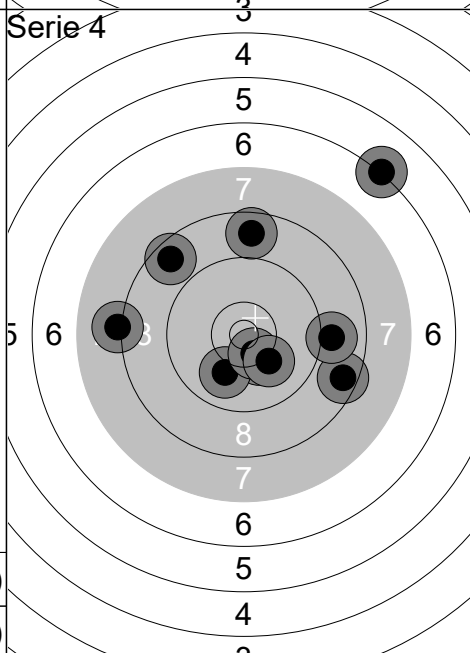

1:	10.3	↘
2:	8.6	↗
3:	10.0	↘
4:	8.5	→
5:	10.5x	↘
6:	9.0	→
7:	8.7	↑
8:	10.1	↘
9:	8.1	←
10:	6.2	↗
Serie		87 (1x)
Total		340 (1x)

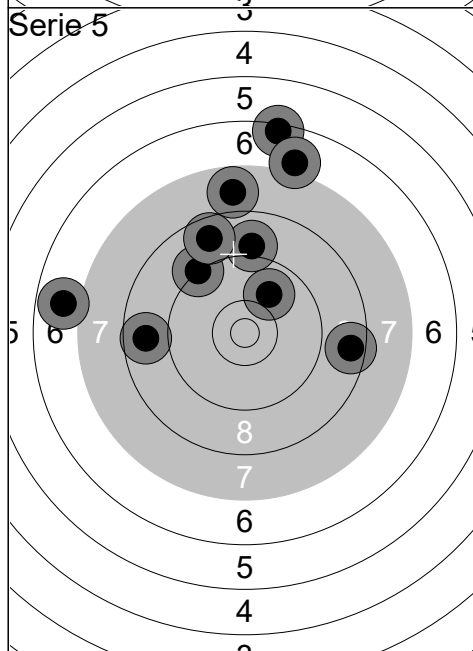

1:	6.9	←
2:	9.0	↑
3:	6.4	↑
4:	7.0	↑
5:	8.7	←
6:	9.2	↗
7:	7.8	↑
8:	9.9	↗
9:	8.7	↖
10:	8.6	→
Serie		77 (0x)
Total		417 (1x)

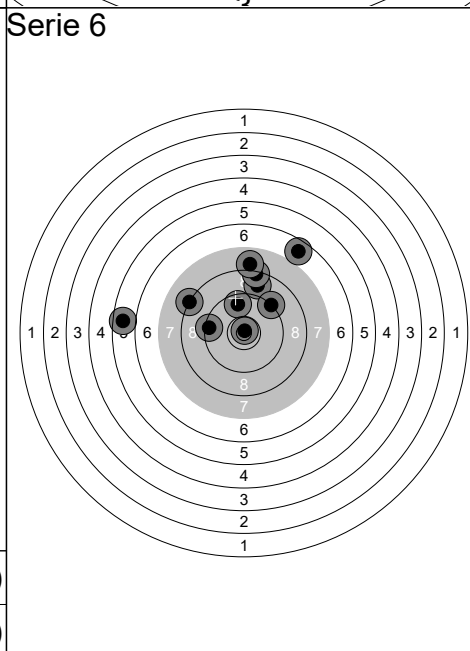

1:	6.7	↗
2:	5.7	←
3:	8.2	↙
4:	9.4	←
5:	9.7	↑
6:	8.8	↑
7:	10.8x	↑
8:	8.3	↑
9:	8.0	↑
10:	9.3	↗
Serie		80 (1x)
Total		497 (2x)

Skjutlag	Tavla	Börje Lundin		
1	37	Vännäs Pistolskytteklubb		H/D 55
22.04.2023		Vårträfen 2023		Umeå skytteallians
	1: 8.4 →		1: 10.0 ↓	
	2: 7.8 ↙		2: 9.9 ↓	
	3: 8.7 ←		3: 10.1 →	
	4: 10.4x ↙		4: 9.5 →	
	5: 8.6 ←		5: 10.2 ↑	
	6: 8.9 →		6: 9.7 ↙	
	7: 8.5 ↙		7: 8.9 ↙	
	8: 9.3 ↓		8: 10.8x ←	
	9: 9.5 ↗		9: 10.4x ←	
	10: 10.2 →		10: 10.7x ↘	
	Serie 85 (1x)		Serie 95 (3x)	
	Total 85 (1x)		Total 180 (4x)	
	1: 10.5x ←		1: 9.4 →	
	2: 9.4 ↓		2: 9.7 ↘	
	3: 10.0 ↗		3: 9.7 →	
	4: 9.3 ←		4: 8.7 ↙	
	5: 8.3 ↗		5: 9.6 ↙	
	6: 9.0 ↙		6: 9.5 ↓	
	7: 10.7x ←		7: 9.8 ←	
	8: 10.0 ←		8: 9.1 →	
	9: 9.8 ↗		9: 9.4 ↙	
	10: 9.4 ↓		10: 9.6 ↙	
	Serie 93 (2x)		Serie 89 (0x)	
	Total 273 (6x)		Total 362 (6x)	
	1: 9.9 →		1: 10.7x ↗	
	2: 10.0 ↗		2: 9.5 ←	
	3: 9.6 ↘		3: 10.0 ↓	
	4: 9.5 ↑		4: 9.8 ↙	
	5: 9.3 ↙		5: 10.7x ↙	
	6: 10.0 ←		6: 10.0 ←	
	7: 10.0 ↓		7: 9.3 ↑	
	8: 9.5 ↙		8: 10.3 ←	
	9: 10.4x ↙		9: 10.4x →	
	10: 10.0 ↓		10: 9.0 ↘	
	Serie 95 (1x)		Serie 96 (3x)	
	Total 457 (7x)		Total 553 (10x)	

Skjutlag 1	Tavla 39	Conny Ström	
1 Luft		Rundviks Pistolskytteklubb	H/D 65
22.04.2023		Vårträfen 2023	Umeå skytteallians
Serie 1		1: 9.4 ↙ 2: 10.4x← 3: 9.9 ↘ 4: 9.8 ↙ 5: 10.3 ↗ 6: 10.1 ↘ 7: 8.6 → 8: 9.9 ↘ 9: 9.5 ↗ 10: 9.5 → Serie 92 (1x) Total 92 (1x)	Serie 2 1: 10.2 ↗ 2: 9.0 ← 3: 9.4 ↗ 4: 10.0 ↘ 5: 10.4x↗ 6: 9.7 ↘ 7: 9.7 ↘ 8: 10.5x→ 9: 10.4x↑ 10: 8.3 ↘ Serie 94 (3x) Total 186 (4x)
Serie 3		1: 9.8 → 2: 8.0 → 3: 9.9 ← 4: 10.1 ↓ 5: 9.9 ↘ 6: 10.4x↙ 7: 8.6 ↓ 8: 9.0 ↘ 9: 9.8 ← 10: 9.1 ↓ Serie 90 (1x) Total 276 (5x)	Serie 4 1: 9.9 ← 2: 8.7 ← 3: 9.9 ↓ 4: 9.7 → 5: 8.4 ↗ 6: 8.8 ↘ 7: 9.6 ← 8: 9.1 ← 9: 7.2 ↓ 10: 10.4 → Serie 86 (0x) Total 362 (5x)
Serie 5		1: 9.5 ↙ 2: 8.4 ↘ 3: 10.1 ↗ 4: 10.2 ↗ 5: 6.8 ← 6: 7.6 ↖ 7: 9.2 ↓ 8: 9.1 ↘ 9: 7.0 ↓ 10: 9.4 ↙ Serie 84 (0x) Total 446 (5x)	Serie 6 1: 9.3 ↑ 2: 9.3 ↖ 3: 9.9 ← 4: 8.4 ↑ 5: 9.1 ↖ 6: 9.0 ↘ 7: 9.9 ↗ 8: 9.3 ↘ 9: 9.6 ↓ 10: 10.0 ↑ Serie 90 (0x) Total 536 (5x)

Skjutlag 1	Tavla 40	Åsa Edvinsson	
1 Luft		Umeå Pistolskytteklubb	D 3
22.04.2023		Vårträfen 2023	Umeå skytteallians
Serie 1		1: 8.5 ↗ 2: 9.6 → 3: 9.0 → 4: 9.9 ↑ 5: 10.3 → 6: 10.1 ↓ 7: 7.3 ← 8: 10.0 ↓ 9: 9.8 ↖ 10: 9.9 ↓	Serie 2
	1: 10.2 ↑ 2: 9.7 ↙ 3: 9.7 ↖ 4: 9.7 ↙ 5: 7.7 ↙ 6: 9.4 → 7: 9.2 ← 8: 10.2 ↑ 9: 10.1 → 10: 8.8 ↑	Serie 90 (0x)	Serie 90 (0x)
Total 90 (0x)	Total 180 (0x)		
Serie 3		1: 10.8x → 2: 9.4 → 3: 9.4 → 4: 9.4 → 5: 8.4 ← 6: 9.4 ← 7: 9.7 ↖ 8: 10.2 ↑ 9: 9.9 ↓ 10: 10.0 ←	Serie 4
	1: 8.3 ← 2: 10.6x ↓ 3: 9.9 ↙ 4: 10.3 → 5: 10.3 ↗ 6: 10.2 ↓ 7: 8.4 ← 8: 8.8 ↓ 9: 10.3 ← 10: 10.4x ←	Serie 92 (1x)	Serie 93 (2x)
Total 272 (1x)	Total 365 (3x)		
Serie 5		1: 10.7x ↓ 2: 9.8 ← 3: 9.3 ↓ 4: 9.9 ← 5: 9.4 ↑ 6: 10.0 ↖ 7: 10.1 ↗ 8: 9.8 ↑ 9: 9.4 ← 10: 9.2 ↓	Serie 6
	1: 9.1 ↖ 2: 9.9 ← 3: 9.9 ↗ 4: 10.1 → 5: 10.2 ↙ 6: 10.2 ↖ 7: 9.2 ← 8: 9.6 → 9: 9.8 → 10: 8.4 ↙	Serie 93 (1x)	Serie 92 (0x)
Total 458 (4x)	Total 550 (4x)		

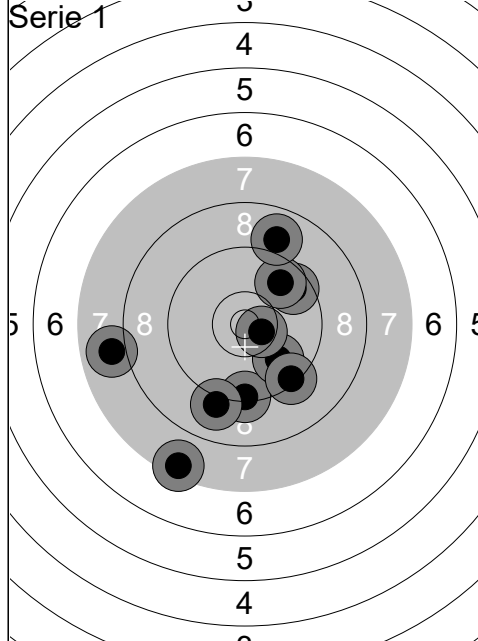

1:	9.3	↓
2:	9.6	↗
3:	7.5	↓
4:	9.9	↘
5:	9.7	↗
6:	7.9	←
7:	9.0	↓
8:	8.9	↑
9:	9.4	↘
10:	10.5x	↘
Serie		86 (1x)
Total		86 (1x)

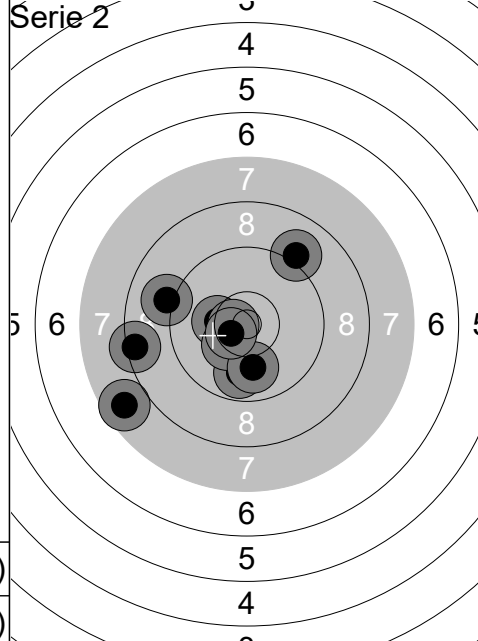

1:	9.9	↓
2:	10.3	←
3:	7.7	↙
4:	10.3	↙
5:	9.1	↗
6:	10.0	↓
7:	8.4	←
8:	10.6x	←
9:	9.1	←
10:	10.5x	↙
Serie		92 (2x)
Total		178 (3x)

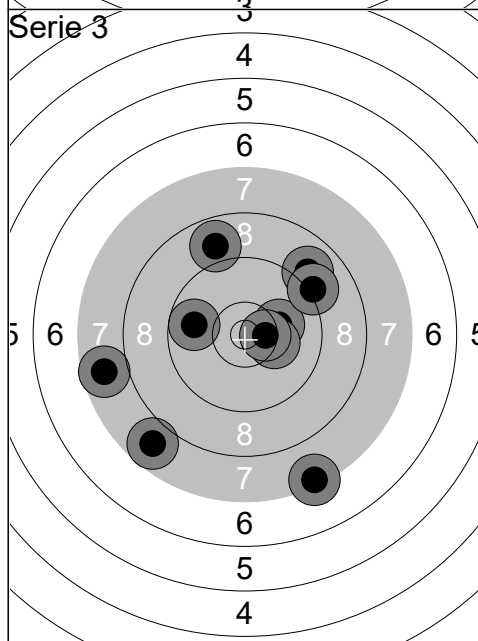

1:	9.0	↗
2:	9.8	←
3:	7.4	↘
4:	8.9	↑
5:	7.7	←
6:	10.2	→
7:	7.8	↘
8:	9.1	↗
9:	10.3	→
10:	10.5x	→
Serie		86 (1x)
Total		264 (4x)

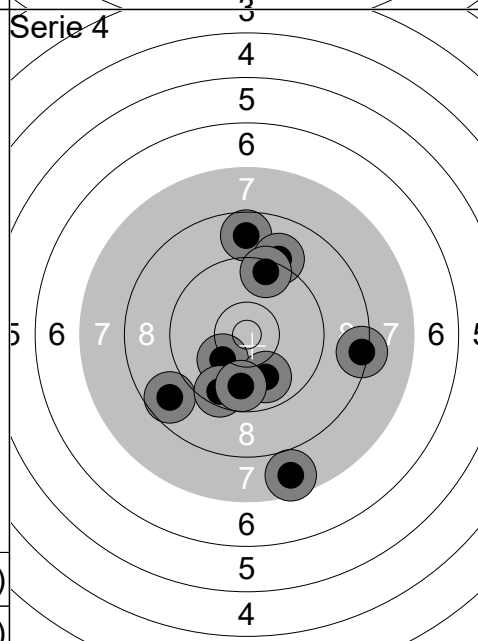

1:	8.7	↙
2:	10.2	↙
3:	9.9	↘
4:	8.7	↑
5:	9.1	↗
6:	9.5	↑
7:	8.4	→
8:	7.7	↓
9:	9.5	↓
10:	9.8	↓
Serie		86 (0x)
Total		350 (4x)

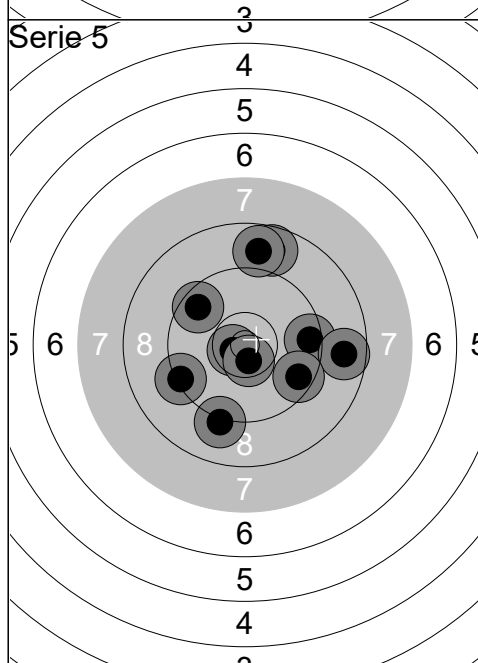

1:	8.7	↑
2:	9.1	↓
3:	8.8	↑
4:	10.7x	←
5:	9.5	→
6:	10.6x	↓
7:	8.7	→
8:	9.3	←
9:	9.5	↘
10:	9.6	↖
Serie		89 (2x)
Total		439 (6x)

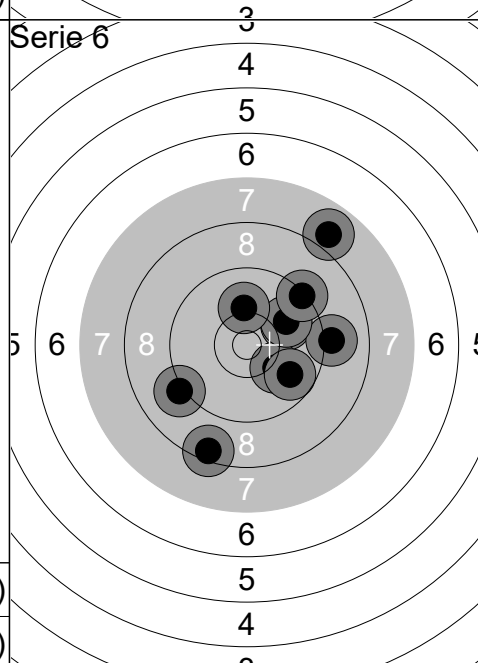

1:	10.0	↗
2:	9.1	↙
3:	9.1	→
4:	10.1	↘
5:	9.9	↗
6:	7.9	↗
7:	9.8	↘
8:	8.4	↓
9:	9.3	↗
10:	10.1	↑
Serie		90 (0x)
Total		529 (6x)

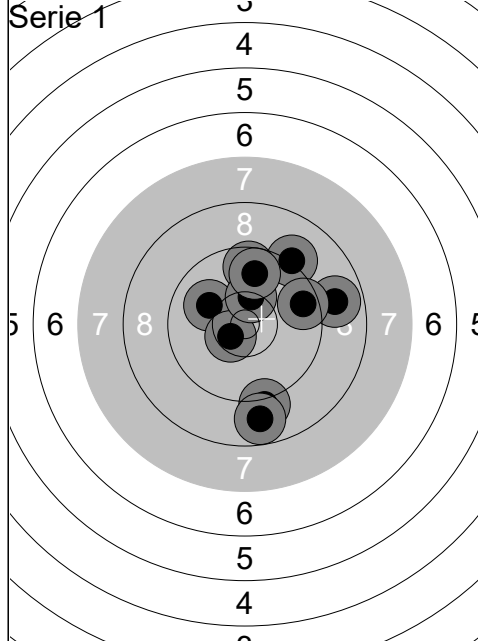

1:	9.1	↓
2:	10.0	↖
3:	9.2	↗
4:	8.8	↓
5:	9.7	↑
6:	10.5x	↙
7:	10.3	↑
8:	8.9	→
9:	9.8	↑
10:	9.6	→
Serie		91 (1x)
Total		91 (1x)

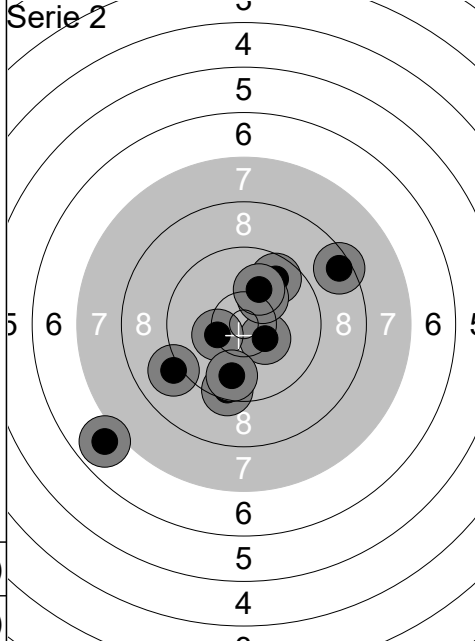

1:	10.4x	↘
2:	8.5	↗
3:	9.4	↓
4:	9.7	↗
5:	10.2	↗
6:	9.1	↙
7:	10.1	↗
8:	6.9	↙
9:	10.3	↙
10:	9.8	↓
Serie		90 (1x)
Total		181 (2x)

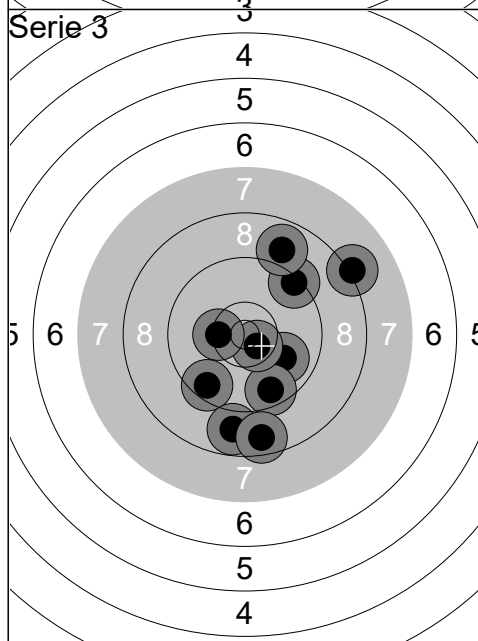

1:	8.2	↗
2:	9.9	↘
3:	9.4	↗
4:	9.5	↙
5:	8.8	↓
6:	9.6	↓
7:	8.6	↓
8:	10.6x	↘
9:	10.4x	↙
10:	8.9	↗
Serie		88 (2x)
Total		269 (4x)

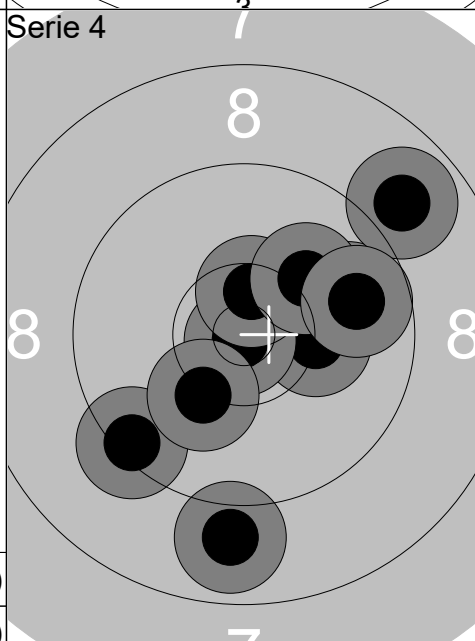

1:	9.8	↗
2:	8.9	↓
3:	10.2	→
4:	10.9x	↙
5:	9.4	↙
6:	8.9	↗
7:	10.2	↙
8:	10.5x	↑
9:	10.1	↗
10:	9.8	↗
Serie		93 (2x)
Total		362 (6x)

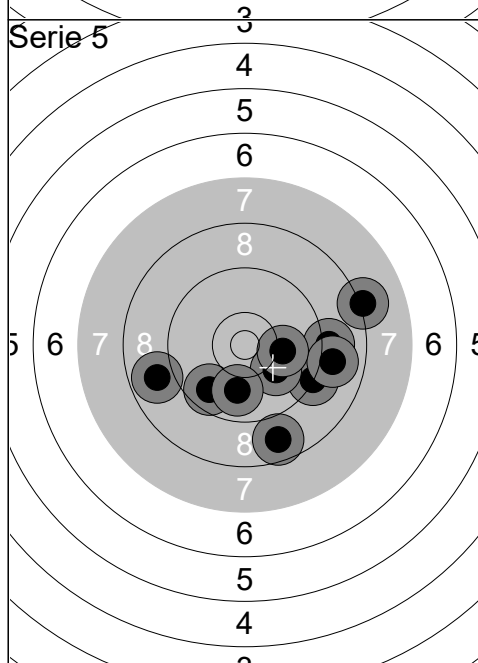

1:	8.2	↗
2:	9.2	↘
3:	9.7	↙
4:	10.1	↙
5:	9.1	→
6:	8.7	↙
7:	8.9	→
8:	8.9	↙
9:	9.9	↓
10:	10.1	→
Serie		88 (0x)
Total		450 (6x)

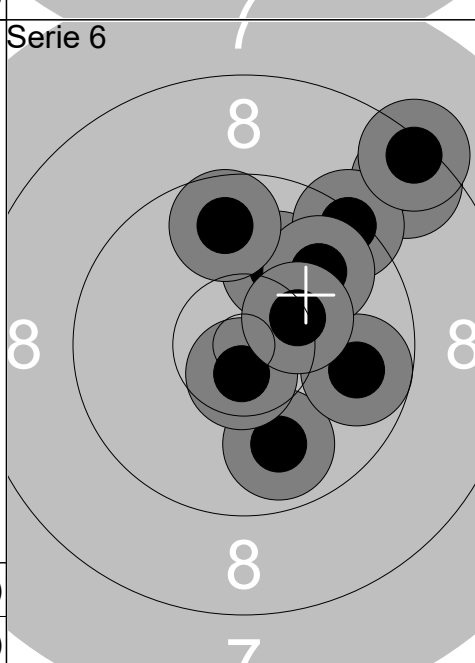

1:	9.9	↓
2:	8.6	↗
3:	10.1	↗
4:	9.8	→
5:	9.3	↗
6:	10.7x	↓
7:	8.4	↗
8:	9.9	↗
9:	10.3	↗
10:	9.7	↑
Serie		91 (1x)
Total		541 (7x)

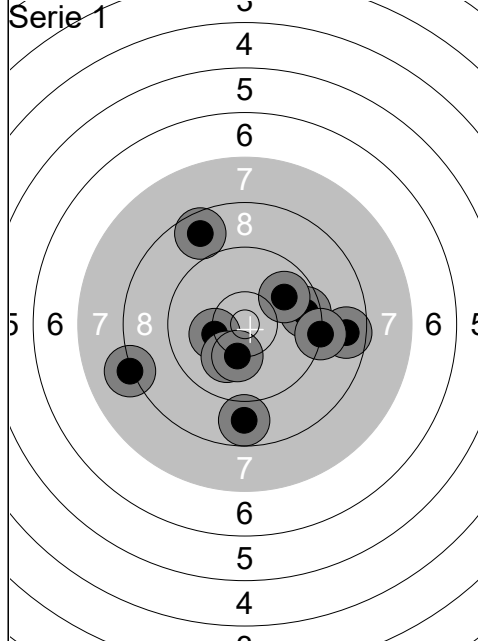

Serie 2

1:	10.2	→
2:	9.9	→
3:	9.0	←
4:	9.3	↙
5:	8.4	↓
6:	9.5	→
7:	8.4	↘
8:	9.3	↓
9:	9.4	↗
10:	7.9	↖
Serie		87 (0x)
Total		176 (0x)

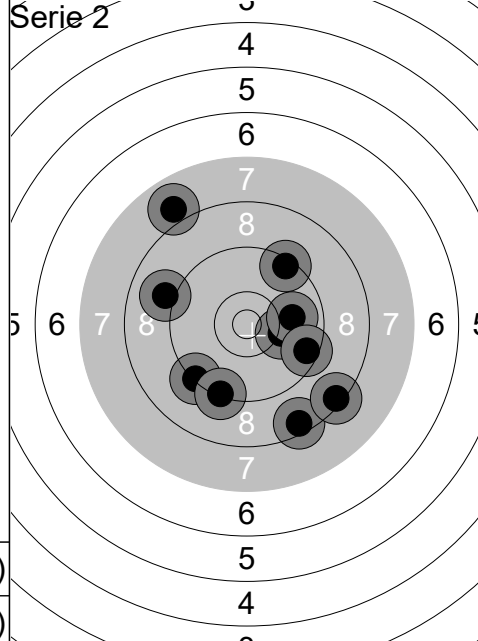

Serie 4

1:	9.3	←
2:	8.3	↙
3:	8.9	→
4:	7.8	↑
5:	6.9	←
6:	8.6	↘
7:	9.2	←
8:	9.1	←
9:	8.0	←
10:	8.7	↙
Serie		80 (0x)
Total		349 (0x)

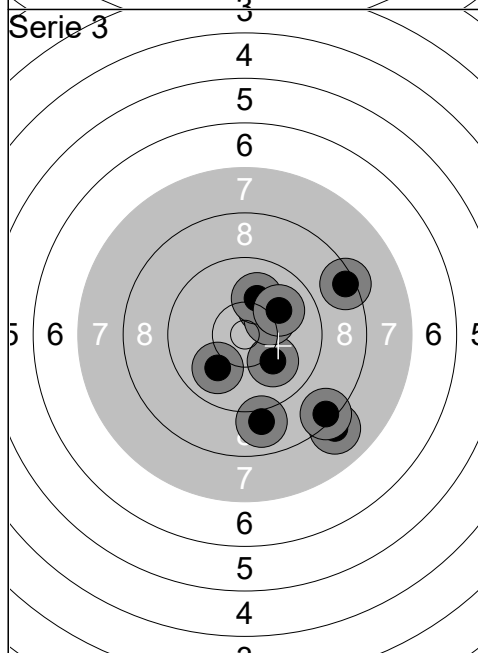

Serie 6

1:	9.1	↓
2:	9.8	→
3:	10.3	↑
4:	9.8	↙
5:	9.0	↙
6:	9.7	↖
7:	9.6	←
8:	8.5	→
9:	7.3	←
10:	8.0	←
Serie		87 (0x)
Total		527 (3x)

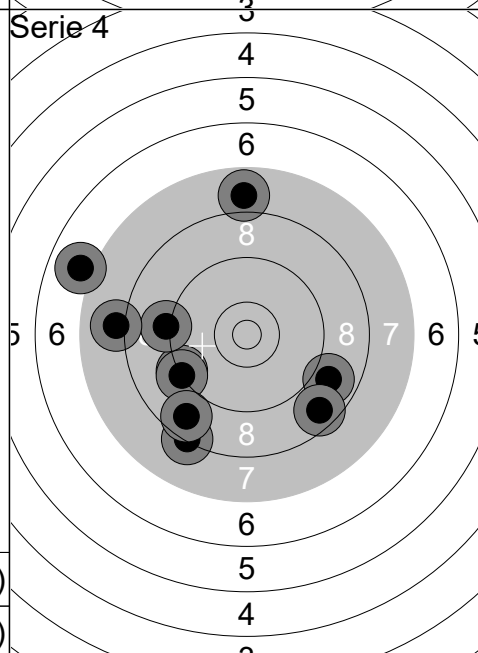

Serie 6

1:	9.1	↓
2:	9.8	→
3:	10.3	↑
4:	9.8	↙
5:	9.0	↙
6:	9.7	↖
7:	9.6	←
8:	8.5	→
9:	7.3	←
10:	8.0	←
Serie		87 (0x)
Total		527 (3x)

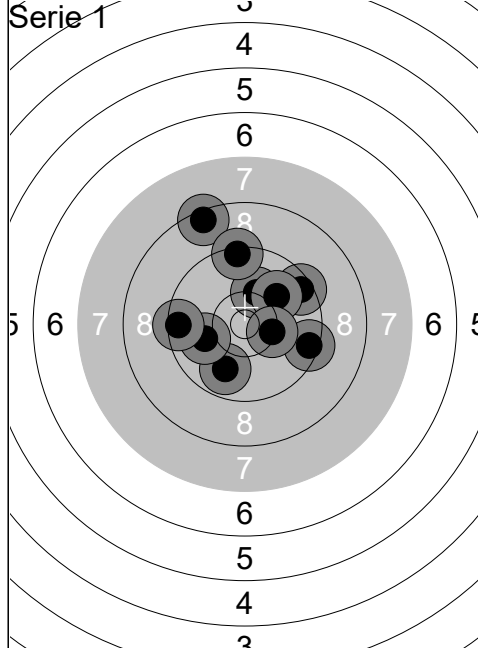

1:	9.4	→
2:	9.9	↓
3:	10.0	←
4:	9.5	↗
5:	8.4	↖
6:	10.2	↗
7:	10.0	↗
8:	9.4	↑
9:	9.5	←
10:	10.3	→
Serie		93 (0x)
Total		93 (0x)

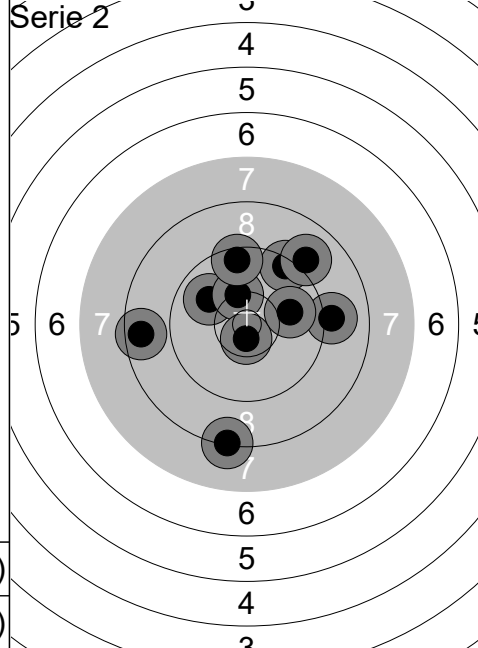

1:	9.9	↖
2:	9.4	↗
3:	10.3	↖
4:	10.6x	↓
5:	9.1	→
6:	9.5	↑
7:	9.9	→
8:	9.0	↗
9:	8.6	←
10:	8.3	↓
Serie		90 (1x)
Total		183 (1x)

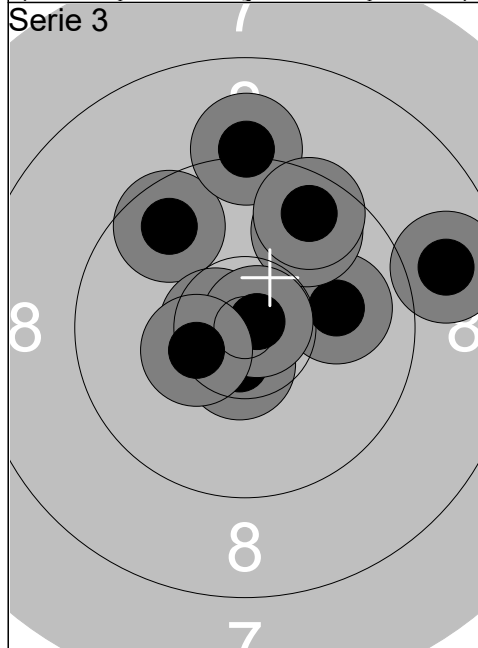

1:	10.0	→
2:	9.8	↗
3:	9.7	↖
4:	8.8	→
5:	10.6x	←
6:	9.1	↑
7:	9.6	↗
8:	10.6x	↓
9:	10.8x	↗
10:	10.4x	↖
Serie		94 (4x)
Total		277 (5x)

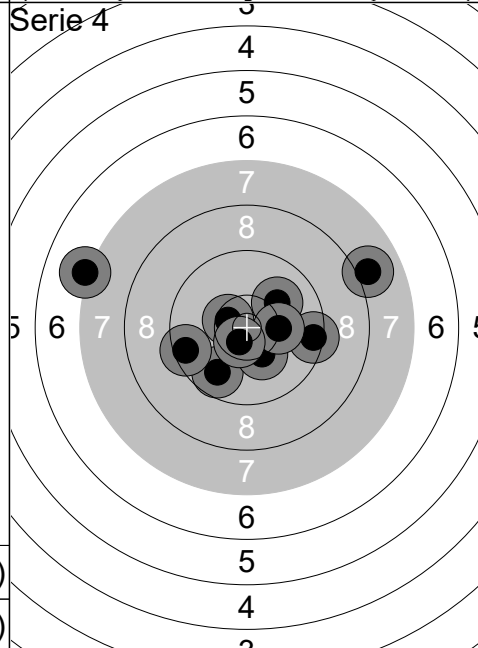

1:	10.1	↗
2:	9.7	↖
3:	7.1	←
4:	10.3	↘
5:	8.0	→
6:	9.4	→
7:	10.2	→
8:	9.5	←
9:	10.5x	↖
10:	10.6x	↘
Serie		92 (2x)
Total		369 (7x)

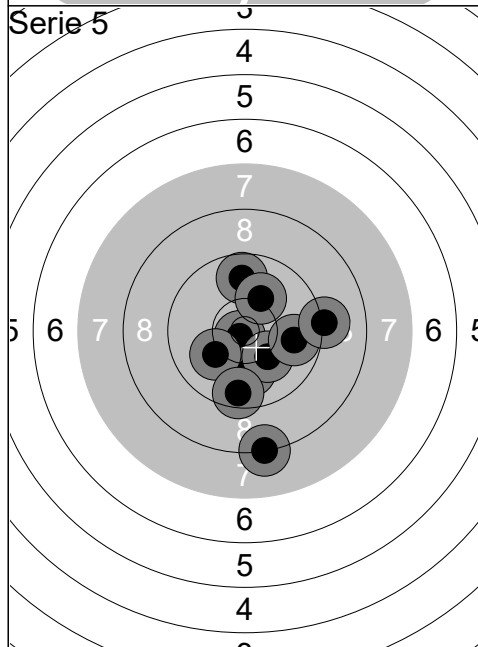

1:	10.8x	↖
2:	9.7	↑
3:	8.2	↓
4:	10.1	↓
5:	10.2	↘
6:	9.8	→
7:	10.1	←
8:	9.5	↓
9:	10.1	↗
10:	9.2	→
Serie		94 (1x)
Total		463 (8x)

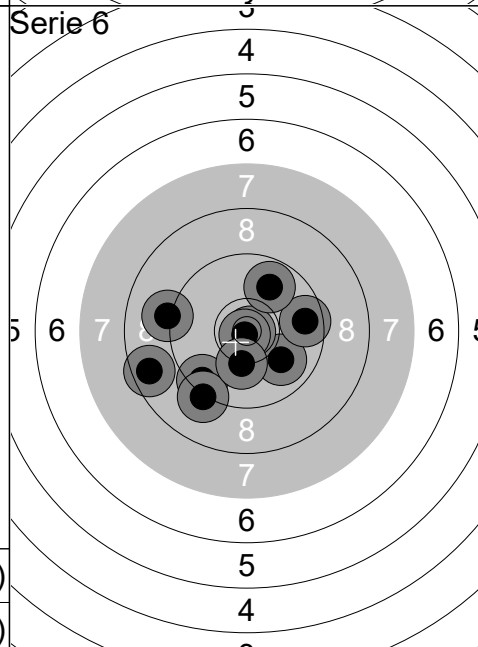

1:	9.9	↘
2:	9.6	→
3:	10.9x	→
4:	8.6	←
5:	9.8	↗
6:	9.5	↘
7:	9.1	←
8:	10.8x	↘
9:	9.2	↘
10:	10.2	↓
Serie		92 (2x)
Total		555 (10x)

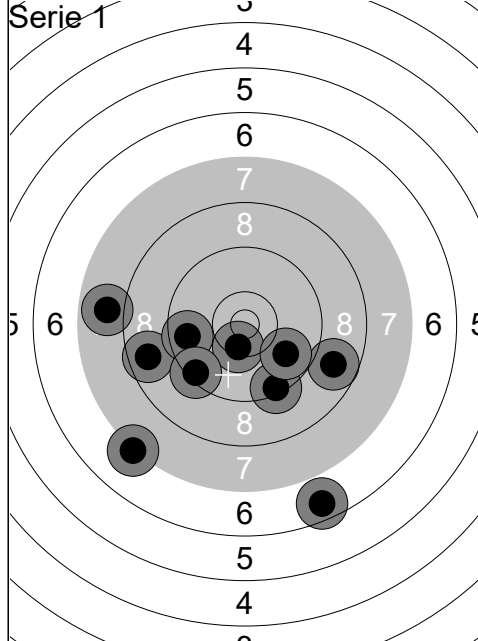

1:	7.2	↙
2:	7.9	←
3:	9.4	↘
4:	10.4x	↘
5:	8.8	➔
6:	9.8	↘
7:	6.6	↘
8:	8.7	←
9:	9.6	←
10:	9.4	↙
Serie		82 (1x)
Total		82 (1x)

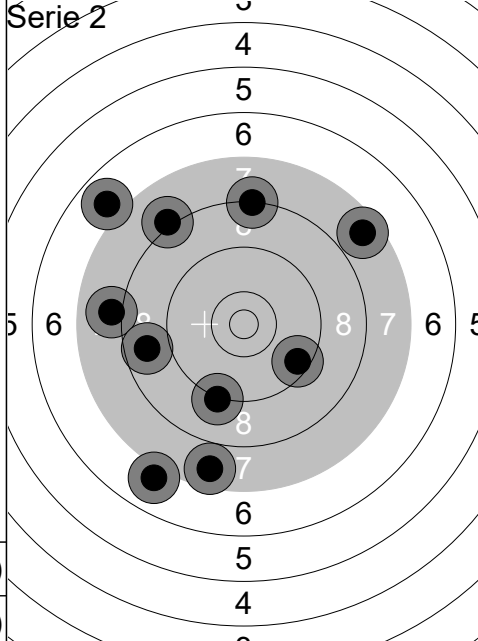

1:	7.6	↗
2:	6.9	↗
3:	9.5	↘
4:	8.1	↗
5:	8.0	←
6:	8.2	↑
7:	8.7	←
8:	7.0	↘
9:	9.2	↘
10:	7.6	↘
Serie		77 (0x)
Total		159 (1x)

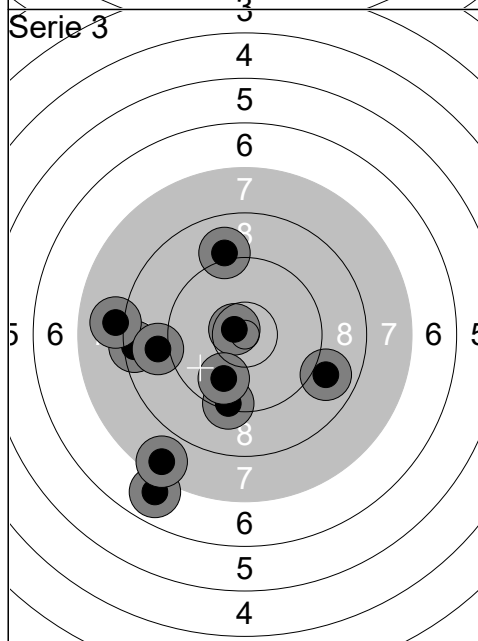

1:	10.7x	↖
2:	8.5	←
3:	8.1	←
4:	9.4	↘
5:	9.0	←
6:	6.9	↘
7:	8.9	➔
8:	9.1	↑
9:	7.6	↘
10:	9.9	↘
Serie		83 (1x)
Total		242 (2x)

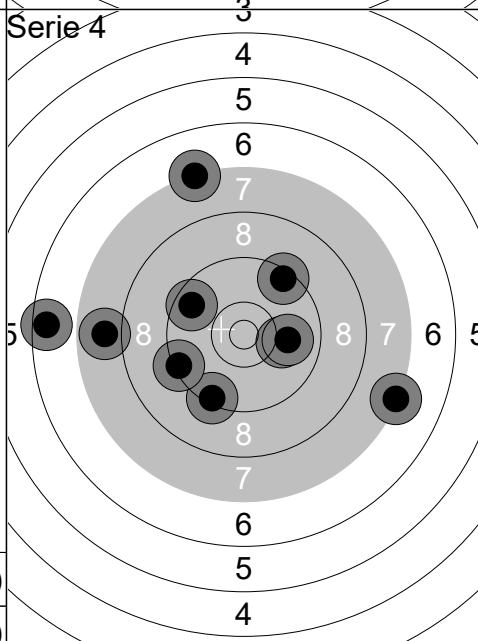

1:	9.6	↖
2:	9.4	↘
3:	6.5	←
4:	10.1	➔
5:	7.8	←
6:	10.0	➔
7:	9.3	←
8:	9.4	↗
9:	7.2	↑
10:	7.3	➔
Serie		83 (0x)
Total		325 (2x)

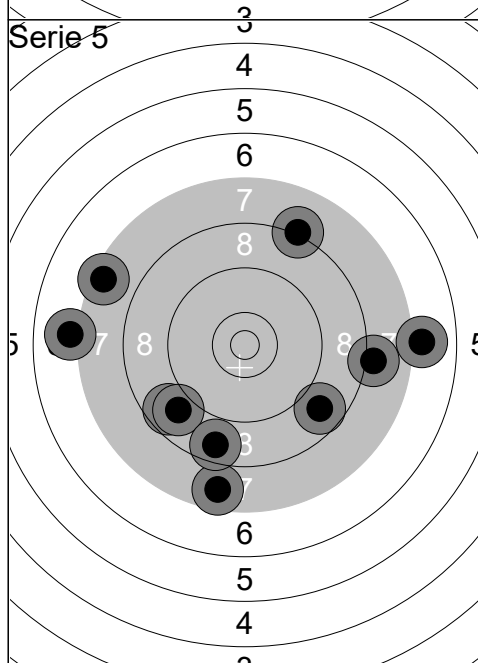

1:	8.7	↙
2:	8.2	↗
3:	7.0	➔
4:	7.0	←
5:	7.7	↘
6:	8.9	↙
7:	8.1	➔
8:	8.6	↘
9:	7.5	↖
10:	8.7	↘
Serie		76 (0x)
Total		401 (2x)

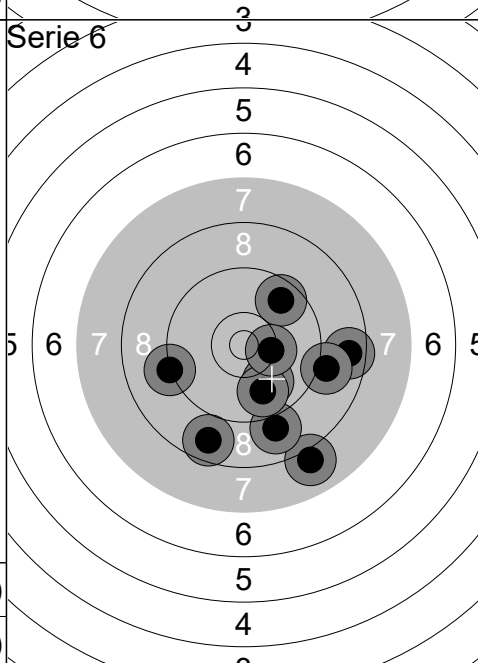

1:	8.0	↘
2:	9.0	↘
3:	8.6	➔
4:	10.0	↘
5:	9.8	↘
6:	9.2	←
7:	9.6	↗
8:	9.0	➔
9:	8.7	↘
10:	10.3	➔
Serie		89 (0x)
Total		490 (2x)

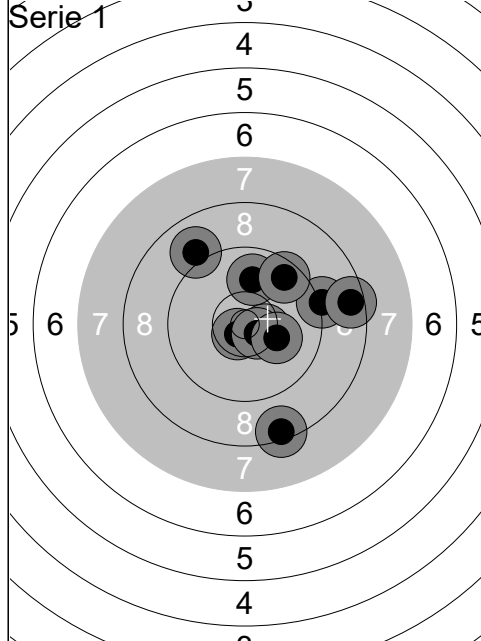

1:	9.9	↑
2:	9.2	→
3:	10.7x	↙
4:	9.0	↑
5:	8.5	→
6:	10.5x	→
7:	10.6x	↘
8:	8.4	↓
9:	9.6	↗
10:	10.2	→
Serie		92 (3x)
Total		92 (3x)

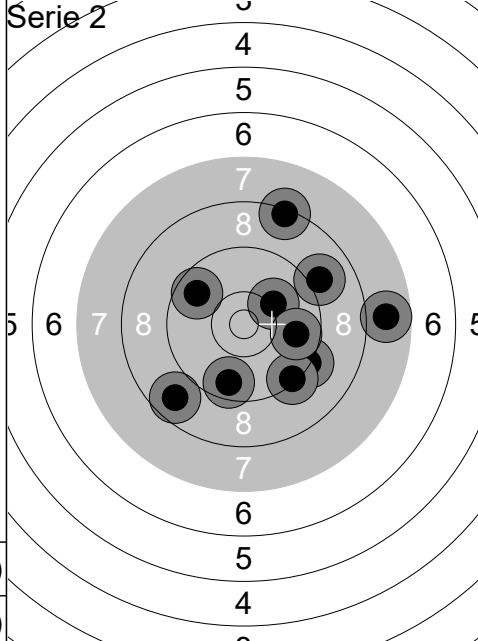

1:	9.6	↓
2:	9.3	↘
3:	9.3	↘
4:	7.8	→
5:	10.1	↗
6:	8.7	↙
7:	8.3	↑
8:	9.7	↖
9:	9.0	↗
10:	9.8	→
Serie		87 (0x)
Total		179 (3x)

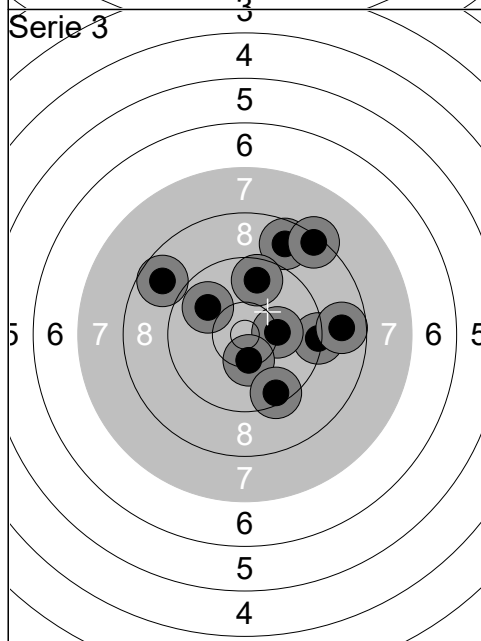

1:	9.3	→
2:	8.7	↑
3:	9.9	↖
4:	10.2	→
5:	9.7	↑
6:	10.4x	↙
7:	8.8	↖
8:	8.4	↗
9:	8.8	→
10:	9.5	↓
Serie		88 (1x)
Total		267 (4x)

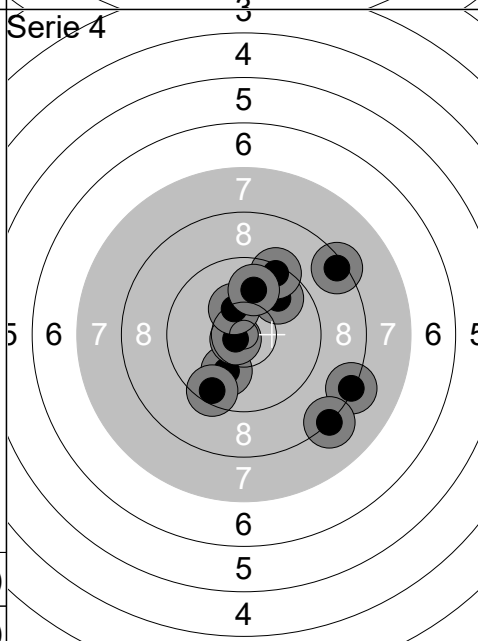

1:	8.4	↗
2:	10.0	↓
3:	9.8	↗
4:	8.3	↘
5:	9.5	↓
6:	10.7x	↙
7:	9.4	↗
8:	10.3	↑
9:	8.2	↘
10:	9.9	↑
Serie		90 (1x)
Total		357 (5x)

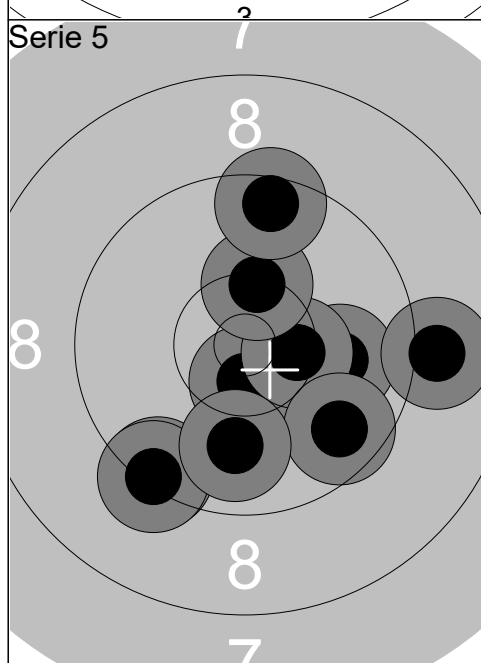

1:	10.6x	↓
2:	10.0	→
3:	10.4x	→
4:	9.4	↙
5:	10.3	↑
6:	9.5	↑
7:	9.3	↙
8:	9.0	→
9:	9.7	↘
10:	9.9	↓
Serie		94 (2x)
Total		451 (7x)

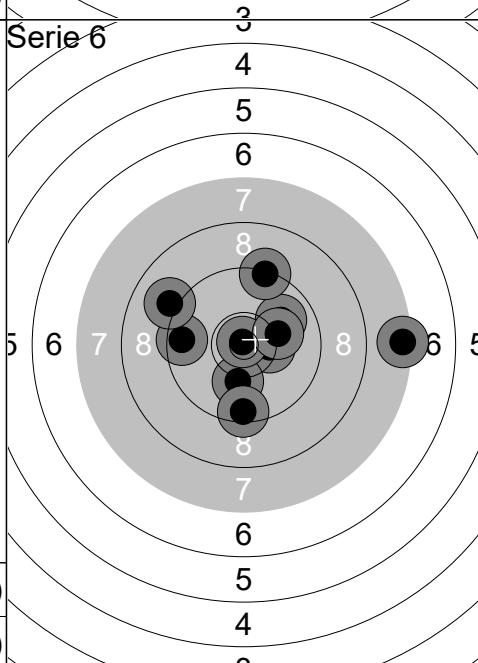

1:	9.9	↗
2:	9.6	←
3:	10.4x	→
4:	10.1	↓
5:	10.9x	↖
6:	9.0	↖
7:	10.1	→
8:	9.3	↑
9:	7.4	→
10:	9.5	↓
Serie		92 (2x)
Total		543 (9x)

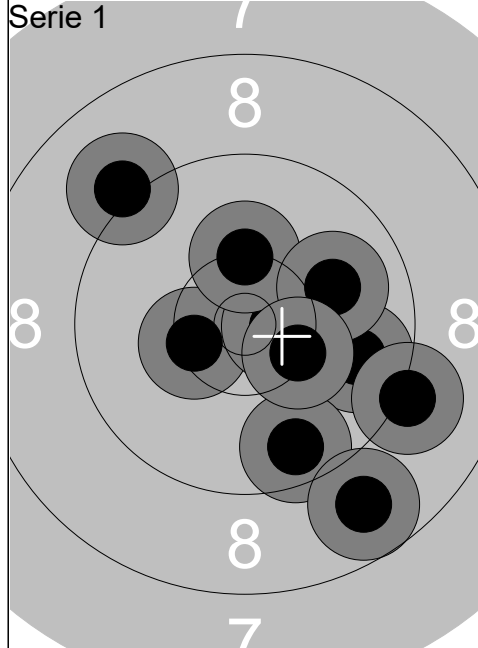

1:	9.8	→
2:	9.6	↓
3:	10.4x	←
4:	10.6x	→
5:	8.8	↓
6:	9.1	↗
7:	10.3	↑
8:	10.0	→
9:	10.3	↘
10:	9.1	↘
Serie		94 (2x)
Total		94 (2x)

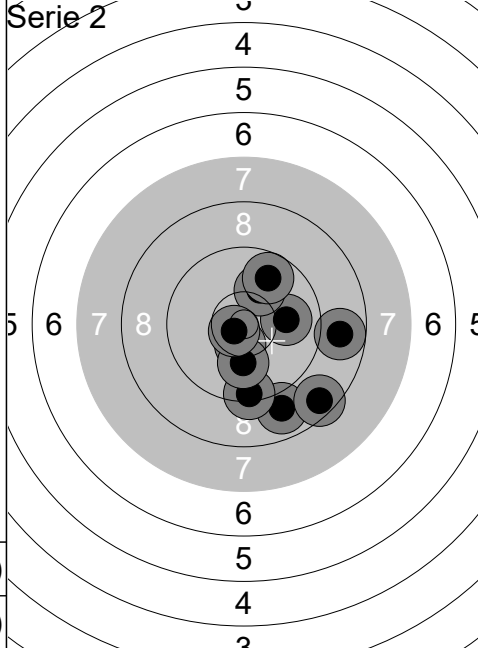

1:	10.5x	↓
2:	10.0	→
3:	8.9	↓
4:	9.4	↓
5:	10.1	↗
6:	8.5	↘
7:	10.1	↓
8:	10.7x	←
9:	8.8	→
10:	9.8	↗
Serie		92 (2x)
Total		186 (4x)

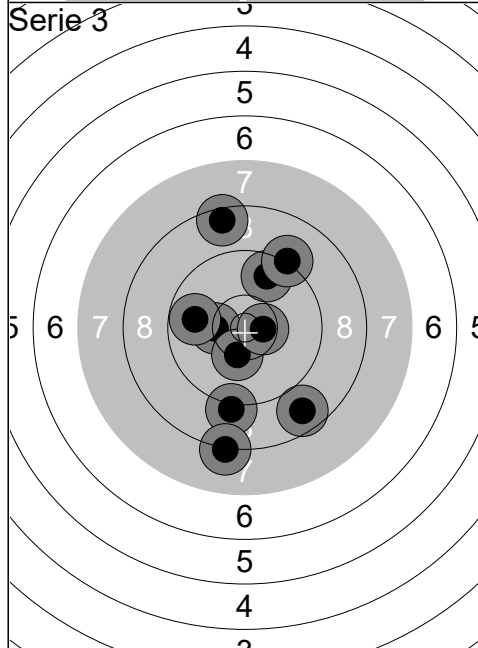

1:	8.7	↘
2:	9.1	↓
3:	10.3	←
4:	8.2	↓
5:	9.7	↗
6:	9.8	←
7:	10.3	↓
8:	8.5	↑
9:	9.2	↗
10:	10.5x	→
Serie		90 (1x)
Total		276 (5x)

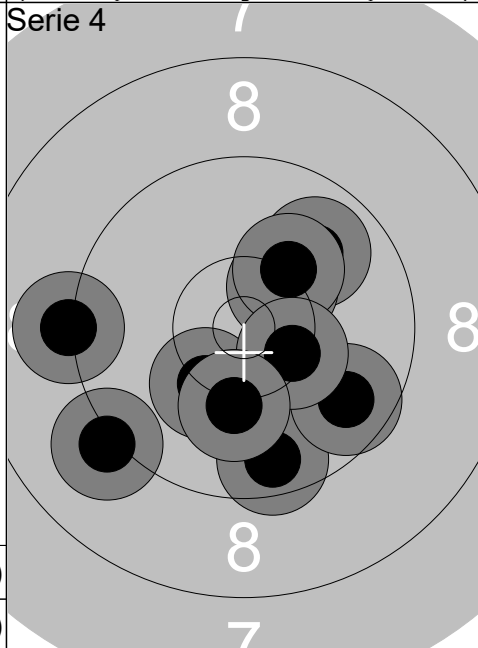

1:	9.9	↗
2:	10.3	↘
3:	10.4x	↗
4:	10.2	↗
5:	9.6	↓
6:	9.7	↘
7:	9.1	↙
8:	10.4x	↘
9:	9.2	←
10:	10.1	↓
Serie		95 (2x)
Total		371 (7x)

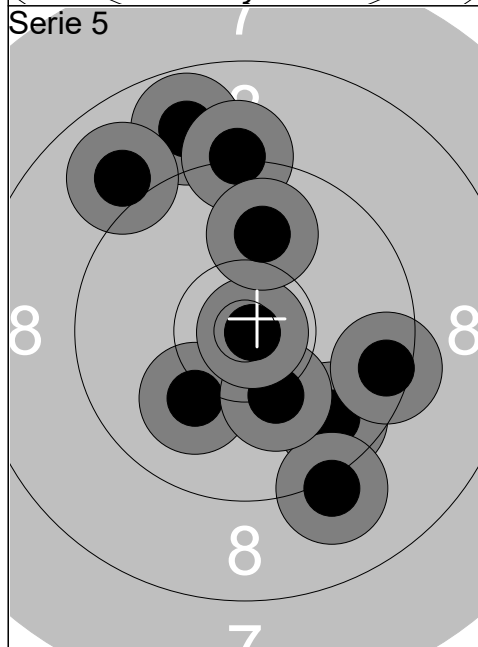

1:	9.7	↘
2:	9.1	↘
3:	9.5	→
4:	10.1	↘
5:	8.8	↗
6:	10.2	↘
7:	9.0	↗
8:	10.9x	→
9:	9.2	↑
10:	9.9	↑
Serie		92 (1x)
Total		463 (8x)

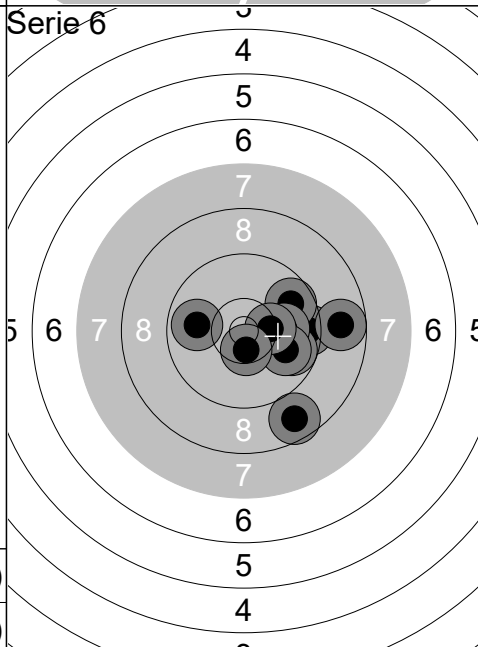

1:	9.5	→
2:	9.8	→
3:	9.7	↗
4:	8.7	↓
5:	10.1	→
6:	9.9	↘
7:	10.4x	→
8:	9.9	←
9:	10.5x	↓
10:	8.8	→
Serie		91 (2x)
Total		554 (10x)

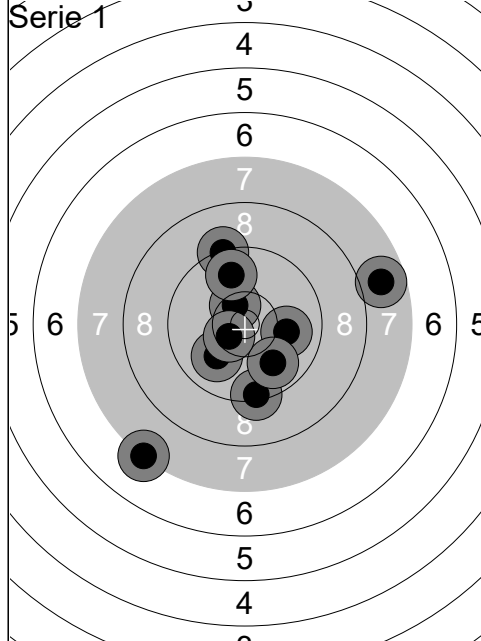

1:	10.0	↙
2:	9.4	↓
3:	10.5x	↗
4:	9.3	↑
5:	7.2	↙
6:	10.0	→
7:	9.9	↙
8:	9.8	↑
9:	7.8	→
10:	10.5x	↙
Serie		90 (2x)
Total		90 (2x)

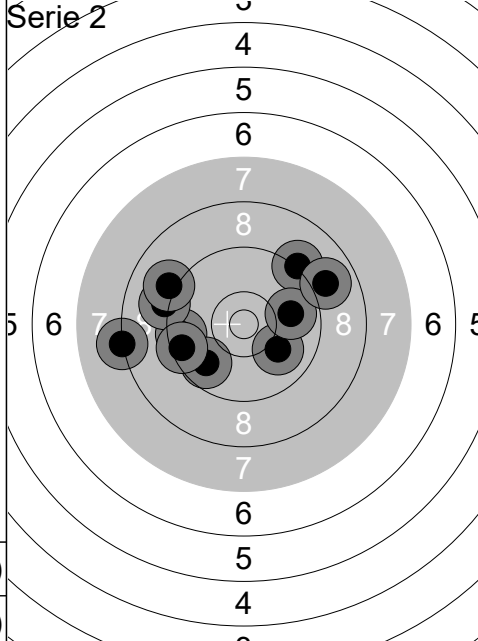

1:	9.5	←
2:	10.0	↘
3:	8.2	←
4:	9.1	←
5:	9.2	↗
6:	9.7	↙
7:	9.5	←
8:	9.9	→
9:	8.9	↗
10:	9.1	↖
Serie		89 (0x)
Total		179 (2x)

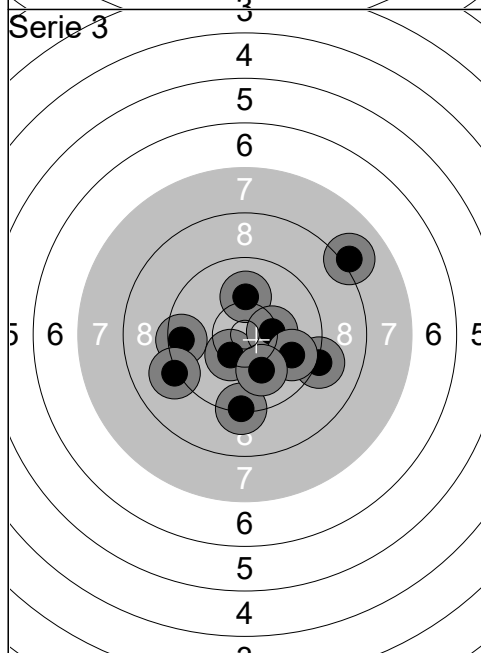

1:	9.5	←
2:	9.3	↓
3:	10.1	↑
4:	9.2	←
5:	10.4x	↘
6:	10.3	→
7:	9.2	→
8:	8.1	↗
9:	9.8	→
10:	10.1	↓
Serie		93 (1x)
Total		272 (3x)

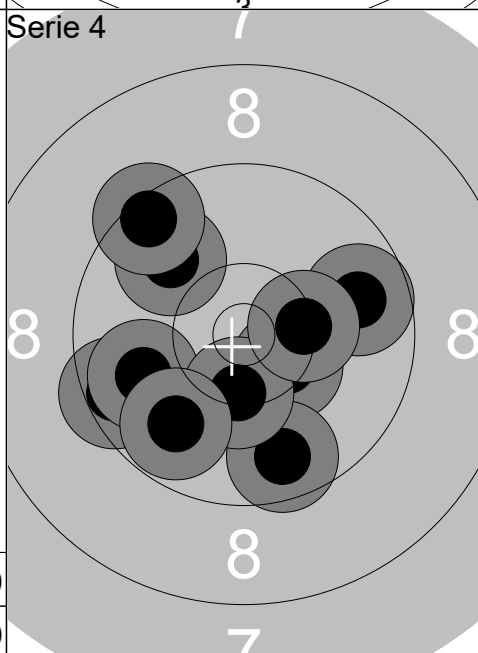

1:	9.5	←
2:	9.7	→
3:	9.9	←
4:	9.9	↗
5:	10.4x	↘
6:	9.4	↗
7:	9.7	↓
8:	10.4x	↓
9:	9.8	↙
10:	10.3	→
Serie		93 (2x)
Total		365 (5x)

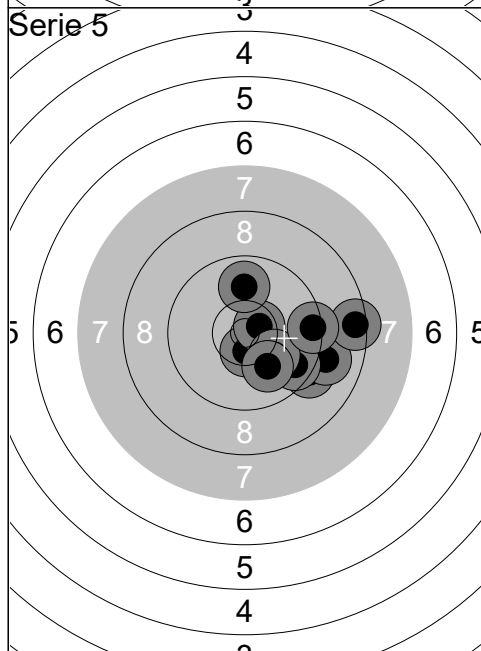

1:	9.3	↘
2:	10.5x	↓
3:	9.0	→
4:	8.5	→
5:	10.6x	↗
6:	9.9	↑
7:	9.6	↙
8:	10.1	↙
9:	9.4	→
10:	10.0	↓
Serie		93 (2x)
Total		458 (7x)

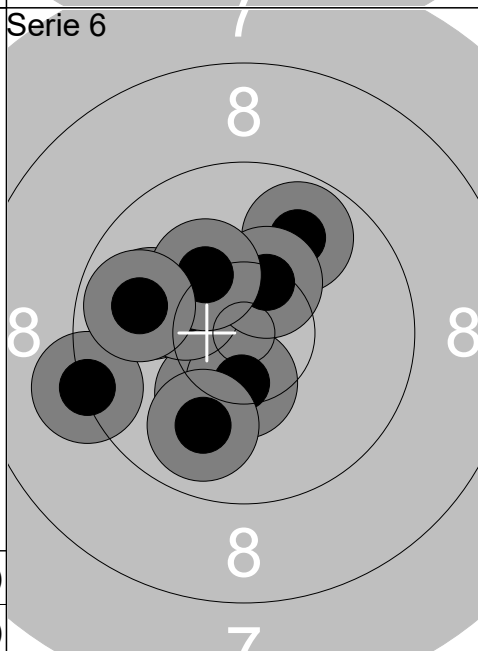

1:	10.3	↙
2:	9.8	↗
3:	10.4x	↓
4:	10.0	←
5:	9.3	←
6:	10.3	←
7:	10.4x	↗
8:	10.2	↗
9:	9.9	↙
10:	9.9	←
Serie		96 (2x)
Total		554 (9x)

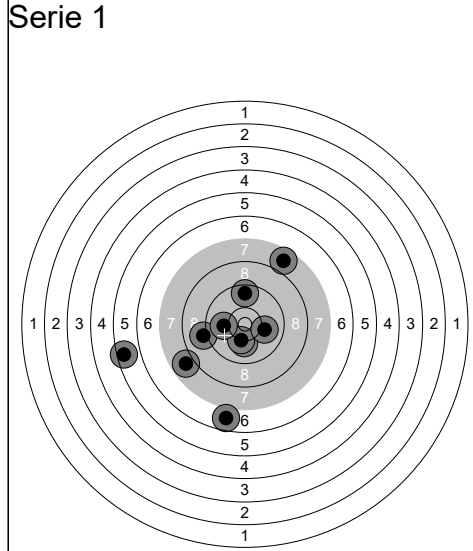

1:	5.5	←
2:	6.8	↓
3:	10.1	↓
4:	10.2	↓
5:	9.0	←
6:	9.6	↑
7:	7.8	←
8:	10.0	←
9:	10.1	→
10:	7.7	↗
Serie		83 (0x)
Total		83 (0x)

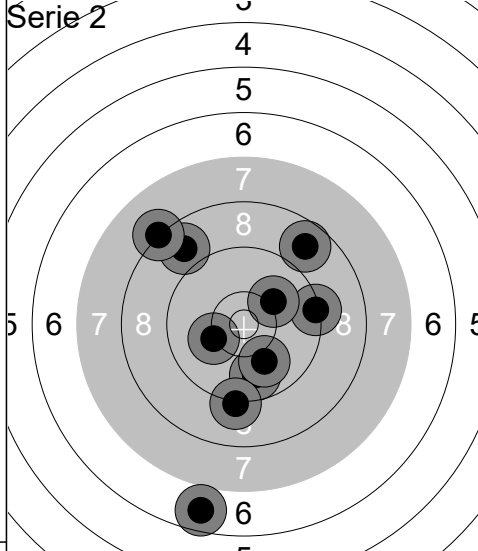

1:	8.8	↗
2:	8.2	↗
3:	6.7	↓
4:	9.8	↓
5:	10.0	↓
6:	9.2	↓
7:	8.7	↗
8:	9.3	→
9:	10.1	↗
10:	10.2	←
Serie		87 (0x)
Total		170 (0x)

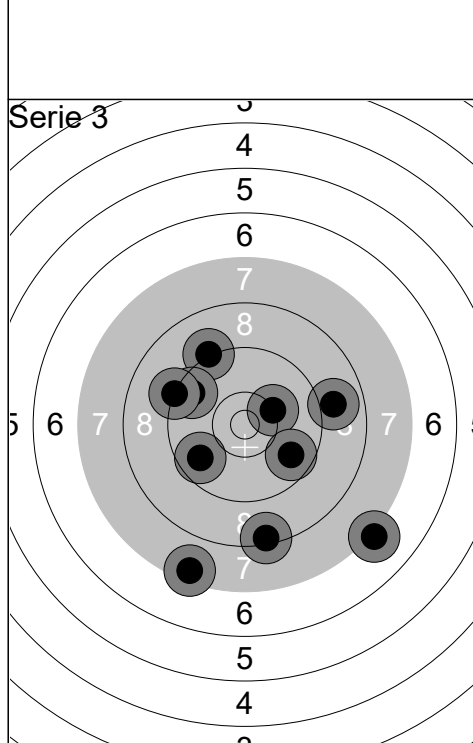

1:	8.9	→
2:	7.1	↘
3:	8.4	↓
4:	9.7	←
5:	9.2	↗
6:	9.6	←
7:	9.2	←
8:	10.2	↗
9:	7.5	↓
10:	9.7	↘
Serie		85 (0x)
Total		255 (0x)

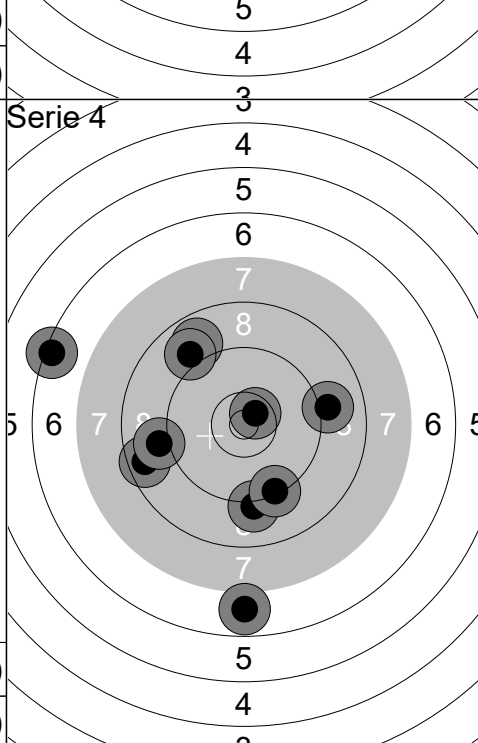

1:	9.1	↓
2:	8.9	↗
3:	9.0	↗
4:	8.6	←
5:	9.0	→
6:	9.0	←
7:	9.3	↓
8:	6.8	↓
9:	10.6x	↗
10:	6.4	←
Serie		83 (1x)
Total		338 (1x)

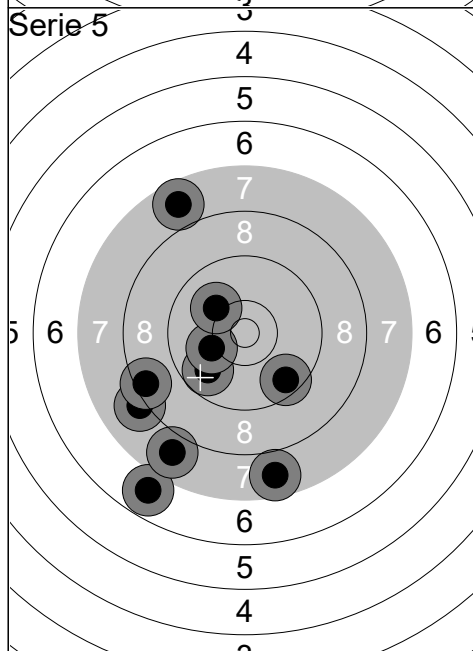

1:	8.1	←
2:	8.5	←
3:	9.8	↘
4:	9.6	↘
5:	6.8	↘
6:	7.7	↘
7:	10.1	←
8:	7.8	↘
9:	7.7	↗
10:	10.1	↘
Serie		81 (0x)
Total		419 (1x)

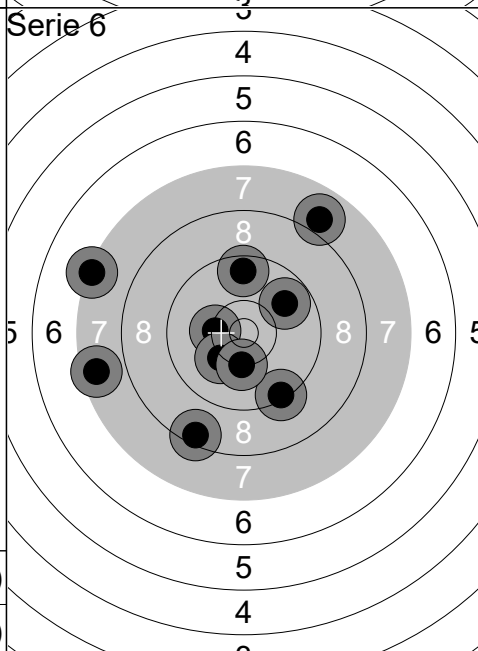

1:	7.9	↗
2:	9.6	↑
3:	9.8	↗
4:	9.3	↓
5:	10.3	←
6:	8.4	↓
7:	10.2	↘
8:	7.3	←
9:	7.6	←
10:	10.2	↓
Serie		86 (0x)
Total		505 (1x)